

OPTIONS

BA100/150
BA300/350
BA400/450

OH & LO Milwaukee offers two styles of oval handles, standard oval and a padlocking oval design. Oval handles are intended for several different applications, they can be installed where a standard lever handle might encounter interference from adjoining piping. Oval handles can also prevent accidental valve operations, since they have less projection than a lever handle, and require more turning force to operate. OSHA requires the use of oval handles in many installations for safety reasons. The locking handle design will accommodate a standard 5/16" pad-lock or other types of valve lockouts. The standard oval handle can be field or factory mounted on BA100/300/400 series valves up to 2", and the locking oval handle can be used on sizes up to 1".

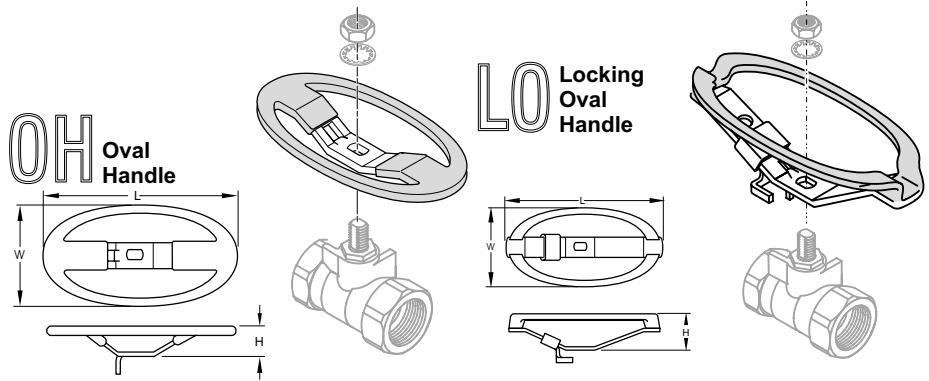

SH Stainless Steel Handle

The "SH" handle option adds a 316 stainless steel handle and nut to a standard bronze ball valve. This option is intended for harsh environments like areas subject to salt water spray, high humidity, harsh cleaning chemicals, etc.

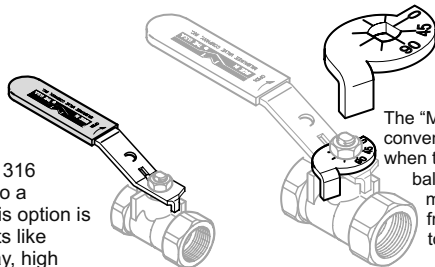

MS Memory Stop

The "MS" Memory Stop offers the convenience of a preset stop when the valve is used in a balancing application. The memory stop can be set from the full closed position, to any preset opening point.

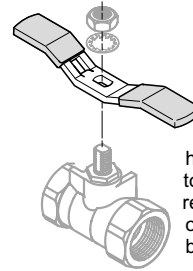

TH Tee Handle

Tee handles offer the same installation space savings as oval handles, with a slightly shorter end to end dimension. Tee handles require more handle force to operate, so accidental openings can be reduced.

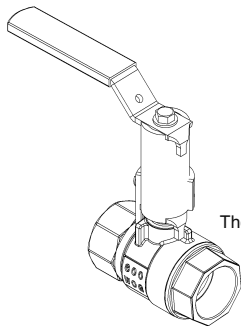

XM Extension Handle with Memory Stop

The "XM" stem extension is all-metallic with an adjustable memory stop. This option is designed for installations where pipe insulation would make standard handles inoperable. The stem extension can also be used

where a handle needs to be raised above an adjoining obstruction. Installations where the valve is mounted behind a panel can be an ideal place for the "XM" stem extension. The adjustable memory stop allows the valve opening to be limited to a preset position. This option can be ordered with or without the memory stop.

CL Chain Lever

Chain lever handle kits are designed for installations where overhead ball valves need to be operated on a regular basis. A length of chain is attached to either end of the handle, so that the operator needs only to pull down on the appropriate chain to open or close the valve.

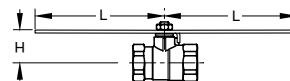

XH Extension Stem

The "XH" stem extension is simple and effective design. This option is designed for installations where pipe insulation would make standard handles inoperable. The stem extension can also be used where a handle needs to be raised above an adjoining obstruction. Installations where the valve is mounted behind a panel can be an ideal place for the "XH" stem extension. The external plastic shield helps to keep the insulation away from the stem extension, providing years of trouble free operation.

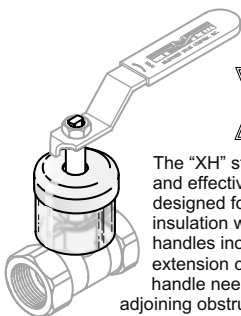

LD Locking Device

The "LD" Locking Handle offers the end user the security of a pad lockable handle. The handle can be locked in either the full open position, or full closed by adding a standard padlock. OSHA requires the use of locking handles in many installations for safety reasons. The locking handle design will accommodate a standard 5/16" pad-lock or other types of valve lockouts. The handle and locking device are also manufactured of stainless steel material for additional strength and corrosion resistance.

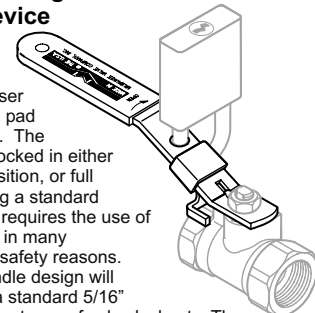

The information presented on this sheet is correct at the time of publication. Milwaukee Valve reserves the right to change design, and/or material specifications without notice. For the Installation, Operation and Maintenance Manual (IOM) see the engineering section on our website. For the most current information access www.milwaukeevalve.com

