



UPBA100/100S 1/4"-3"



Bronze Ball Valve For Potable Water
Two Piece
Standard Port (1" - 3") Full Port (1/4" - 3/4")
600 psig WOG
Threaded Ends
Blow-Out Proof Stem
Dimensions and Workmanship Conform to MSS SP-110

MATERIAL LIST

ITEM	PART	MATERIAL	ASTM SPEC
1	Body	Cast Bronze	B584 C89833
2	Tailpiece	Cast Bronze	B584 C89833
3	Ball	Brass w/Hard Chrome Plating	B283 C27450
		316 Stainless Steel (1)	A276 S31600
4	Seat	RPTFE, 15% Glass filled	Commercial
5	Stem	Brass	B21 C46400
		316 Stainless Steel (1)(2)	A276 S31600
6	Thrust Washer	RPTFE, 25% Glass Filled	Commercial
7	Packing	PTFE	Commercial
8	Packing Nut	Brass	B16 C36000
9	Handle	Steel w/Zinc Plating	B633
10	Handle Grip	Vinyl	Commercial
11	Handle Nut	Steel w/Zinc Plating	B633
12*	Body Seal	PTFE	Commercial

(1) Ball and stem are stainless for UPBA100S

(2) Ball and stem are stainless for 2 1/2" & 3" UPBA100

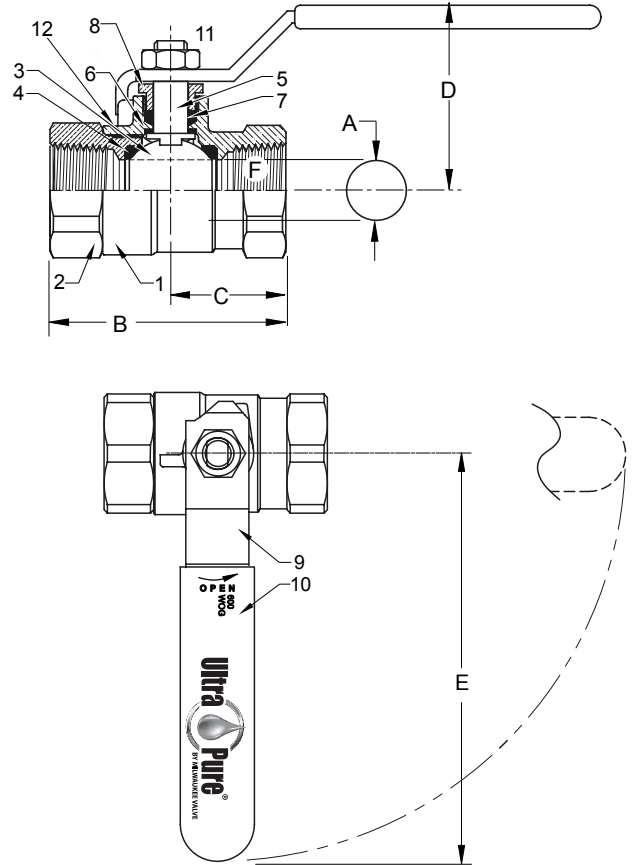

DIMENSIONS

	UNITS	1/4" DN6	3/8" DN10	1/2" DN15	3/4" DN20	1" DN25	1-1/4" DN32	1-1/2" DN40	2" DN50	2-1/2" DN65	3" DN80
A (DIA)	INCHES	0.38	0.38	0.50	0.76	0.88	1.06	1.31	1.56	2.00	2.31
	mm	10	10	13	19	22	27	33	40	51	59
B	INCHES	1.86	1.86	2.19	2.59	3.17	3.50	3.96	4.30	5.58	6.17
	mm	46	46	54	66	78	86	97	105	142	157
C	INCHES	1.00	1.00	1.10	1.30	1.58	1.74	1.97	2.15	2.79	3.10
	mm	25	25	27	32	39	43	48	53	71	79
D	INCHES	1.78	1.81	1.91	2.08	2.25	2.66	2.84	3.00	3.44	3.84
	mm	44	44	47	51	55	65	70	74	87	98
E	INCHES	3.81	3.81	3.81	4.56	4.56	6.31	6.31	7.19	7.19	7.19
	mm	93	93	93	112	112	155	155	176	176	176
F	THREAD SIZE	1/4" NPT	3/8" NPT	1/2" NPT	3/4" NPT	1" NPT	1-1/4" NPT	1-1/2" NPT	2" NPT	2-1/2" NPT	3" NPT
Cv		7	7	13	30	38	61	87	121	228	305

Note: DN (Diameter Nominal) = Metric equivalent size.

*2-1/2" & 3" Only.

Note: Lead free refers to the wetted surface of the pipe, fittings and fixtures in potable water systems that have a weighted average lead content $\leq 0.25\%$. Source: California Health and Safety Code (116875).

The information presented on this sheet is correct at time of publication. Milwaukee Valve reserves the right to change design and/or materials without notice. For our Installation, Operation and Maintenance Manual and the most current product information go to www.milwaukeevalve.com.

⚠ State of California Prop 65 **WARNING:** Cancer and Reproductive Harm. For more information visit www.p65warnings.ca.gov.



OPTIONS

UPBA100/150 / BA100/150
 UPBA300/350 / BA300/350
 UPBA400/450 / BA400/450

TIH THE INSULATOR/MS® Extension Handle

The **THE INSULATOR/MS®** extension handle is designed to prevent condensation and other extraneous moisture from entering the insulated piping system, while also minimizing thermal energy loss from the system via metal extension tubes, levers, and similar parts.



The design incorporates a unique memory stop feature that requires no disassembly or removal of the handle to engage and make adjustments.

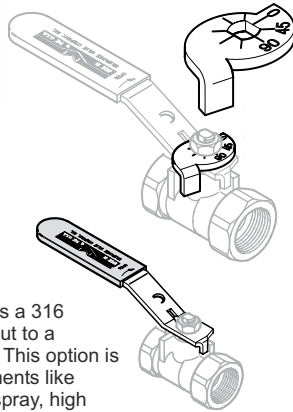

XLD Locking Extension



The -XLD extended locking handle is made of robust plated steel and provides additional safety benefits for the user. The handle can be locked in both the open and closed positions. Extension length provides for handle clearance above standard piping insulation thicknesses.

SH Stainless Steel Handle

The "SH" handle option adds a 316 stainless steel handle and nut to a standard bronze ball valve. This option is intended for harsh environments like areas subject to salt water spray, high humidity, harsh cleaning chemicals, etc.

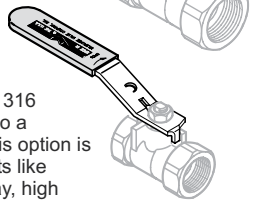

TH Tee Handle

Tee handles offer the same installation space savings as oval handles, with a slightly shorter end to end dimension. Tee handles require more handle force to operate, so accidental openings can be reduced.

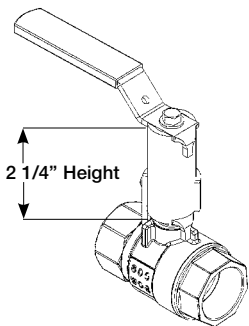
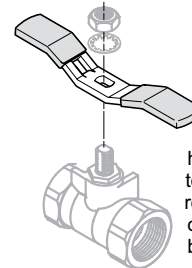

XM Extension Handle with Memory Stop

The "XM" stem extension is all-metallic with an adjustable memory stop. This option is designed for installations where pipe insulation would make standard handles inoperable. The adjustable memory stop allows the valve opening to be limited to a preset position. This option can be ordered with or without the memory stop.

OH & LO Milwaukee offers two styles of oval handles, standard oval and a padlocking oval design.

Oval handles can prevent accidental valve operations, since they have less projection than a lever handle, and require more turning force to operate. OSHA requires the use of oval handles in many installations for safety reasons. The locking handle design will accommodate a standard 5/16" pad-lock or other types of valve lockouts.

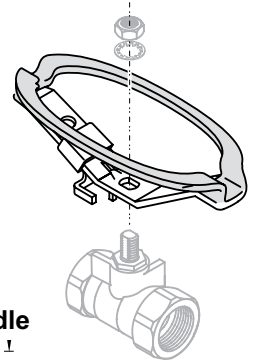

OH Oval Handle

XH Extension Stem

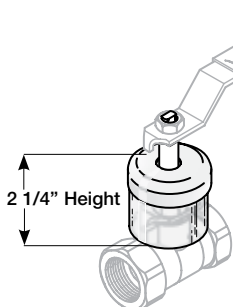

The "XH" stem extension is simple and effective design. This option is designed for installations where pipe insulation would make standard handles inoperable. The external plastic shield helps to keep the insulation away from the stem extension, providing years of trouble free operation.

LD Locking Device

The "LD" Locking Handle offers the end user the security of a pad lockable handle. The handle can be locked in either the full open position, or full closed by adding a standard padlock. The locking handle design will accommodate a standard 5/16" pad-lock or other types of valve lockouts. The handle and locking device are also manufactured of stainless steel material for additional strength and corrosion resistance.

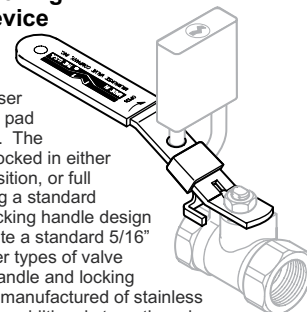

The information presented on this sheet is correct at time of publication. Milwaukee Valve reserves the right to change design and/or materials without notice. For our Installation, Operation and Maintenance Manual and the most current product information go to www.milwaukeevalve.com.
 ⚠ State of California Prop 65 **WARNING:** Cancer and Reproductive Harm. For more information visit www.p65warnings.ca.gov.

